

**GLISS
MASTER
SMART FITTINGS**

GLISS MASTER

SMART FITTINGS

Prices in Euro currency.
VAT, IVA, MOMS, MwSt, BTW, TVA and any value added taxes not included.
Designing, transport and assembly not included.
Molteni&C Spa reserves the right to makes changes to its products, sizes
and materials at any time and without prior notice.

Molteni & C





Introduction of the open corner element without pillar for the QUICK and A FILO doors.





LED LIGHTING

Vertical lighting is inserted in the full-height panel, positioned in front of the accessory for full lighting, even when the drawer is open.

DRAWER UNITS

Drawer unit with 2/3/4 fully extractable drawers.

The drawer unit can be reduced in width without a filler panel for maximum containment of the drawer.

Handle in black finish.

CLOTHES RODS

Tubes in black finish.



LAMINATE UPDATE

The QUICK door is available with all front piece laminates, combined with a pewter or bronze epoxy finish handle.

A FILO doors also include the Tatami and Chestnut laminates.



TECHNICAL UPDATES

Reduction of the minimum width to 15 mm for assembly in a niche, due to the use of special hardware.

With lighting systems, the minimum height for assembly in a niche is reduced due to the use of inspection panels.

Introduction of the open corner element without pillar for the QUICK and A FILO doors.

This tool was designed to simplify and speed up the quoting phase for the point of sale.

Choice of wardrobe size, including doors.

Choice of interior accessories with predetermined arrangements A, B, C ...

The lighting system can be inserted.

At the end, we have a single quote for the elements in the composition, for possible modification: addition or elimination.

Gliss Master "Smart" fittings Composition 2

W 1998
modules 984 - 984

*- For visible side panels with Cartapaglia and Silk melamine, Lunar and Glaze front, include the supplementary cost for matt lacquered side panels.
- Compositions with FIND-ME and HOLLOW doors are not available in every finish.
- For custom reduction surcharges check on page 36*

Structure with doors	QUICK		FIND-ME HOLLOW A FILO		SMOOTH START TWIN		GRIP	
	UB/B	FB/B	CB/B	SB/B	GB/B	GB/B	GB/B	
melamine front	1.990	2.096	1.942	2.024				
matt lacquer colours	2.382	2.382	2.202	2.288				
vertical grain wood	3.304	3.304	3.144	3.236				
Lunar (only FIND-ME)	3.418							
glossy lacquer colours	4.080		3.906	4.004				
Glaze	4.580		4.508					
coloured/etched col. glass	3.664							
Eco Skin			4.658					

Internal fittings

Code	Q.ty	€	Code	Q.ty	€		
A Complete fittings € 116							
Wood shelves W 954	RU/9	1	60	Wood shelves W 954	RU/9	1	60
"Smart" clothes rails W 954	PP/09	2	56	"Smart" clothes rails W 954	PP/09	2	56
B Complete fittings € 638							
Wood shelves W 954	RU/9	1	60	Wood shelves W 954	RU/9	1	60
"Smart" clothes rails W 954	PP/09	1	28	"Smart" clothes rails W 954	PP/09	2	56
"Smart" drawer units 3 drawers W 954	CNT3/08PA	1	550	"Smart" drawer units 2 drawers W 954	CNT2/08PB	1	405
C Complete fittings € 645							
Wood shelves W 954	RU/9	4	240	Wood shelves W 954	RU/9	1	60
"Smart" drawer units 2 drawers W 954	CNT2/08PB	1	405	"Smart" clothes rails W 954	PP/09	1	28
D Complete fittings € 521							
Wood shelves W 954	RU/9	1	60	Wood shelves W 954	RU/9	1	60
"Smart" clothes rails W 954	PP/09	2	56	"Smart" clothes rails W 954	PP/09	2	56
"Smart" drawer units 2 drawers W 954	CNT2/08PB	1	405	Dividing panels H 1158	SDT/11	1	102
E Complete fittings € 335							
Wood shelves W 954	RU/9	1	60	Wood shelves W 462	RU/4	3	123
"Smart" clothes rails W 954	PP/09	1	28	"Smart" clothes rails W 462	PP/04	1	22

Lighting system complete with sensors power supply and connector

N.1 vertical LED bar each compartment	542	excluding remote control
N.2 vertical LED bars each compartment	845	excluding remote control

Additional elements

Wood shelf W 954	RU/9	60	"Smart" drawer unit 3 drawers W 462	CNT4/08PA	448
Wood shelf W 462	RU/4	41	"Smart" drawer unit 4 drawers W 462	CNT4/08PA	564
"Smart" clothes rails W 954	PP/09	28	Supplementary cost for matt lacq. side panels	each couple	226
"Smart" clothes rails W 462	PP/04	22	Supplementary cost for glossy lacq. side panels	each couple	358
"Smart" drawer unit 2 drawers W 954	CNT2/08PB	405	Supplementary cost for wood side panels	each couple	578
"Smart" drawer unit 3 drawers W 954	CNT3/08PA	500	START door - extra charge for "M" handle	each.	47
"Smart" drawer unit 4 drawers W 954	CNT3/08PA	694	GRIP door - extra charge for Eco Skin version	each.	22
"Smart" drawer unit 2 drawers W 462	CNT4/08PB	331			

Molteni & C 17

Clothes rails

For use only with wood shelves.
Black finish.
Supplementary cost of € 7 for cut in width.

Drawer units

Floor-standing or wall-mounted drawer units with drawers H 190 mm equipped with handles in black finish.
2, 3, and 4 drawer versions cannot be modified.
The drawer units are not stackable. In the event that requirements are different, use standard modular drawer units.
The width of the drawer units can be reduced for a surcharge of:
€ 105 2-drawer unit, € 140 3-drawer unit, € 175 4-drawer unit

Clothes rails

	W 298	W 380	W 462	W 626	for external corner unit	W 790	W 954	W 1282	
	PP/03	PP/02	PP/04	PP/06	PPB/06	PP/08	PP/09	PP/13	PPA/06
black	19	20	22	24	24	26	28	41	24

Clothes rail for corner compartment with doors

Clothes rails

Clothes rail for D 435
to mount on wood shelves or top only with hinged doors

1 piece on compartment W 626/790
2 pieces on compartment W 954/1282

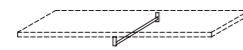

PPQ/04

black	22
-------	----

Clothes rails for open corner compartment

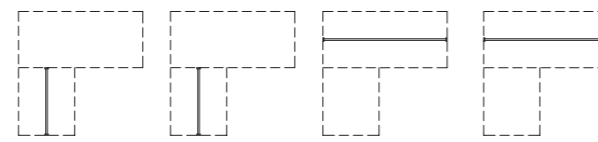

W 543	W 723	W 1081	W 1262
PPA/05	PPA/07	PPA/11	PPA/13

Drawer units floor standing or suspended

H 420
2 wooden drawers H 190

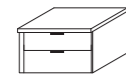

W 462	W 626	W 790	W 954	W 1282
CNT4/04PB	CNT6/04PB	CNT8/04PB	CNT9/04PB	CNT13/04PB

melamine	331	366	386	405	513
----------	-----	-----	-----	-----	-----

Drawer units floor standing or suspended

H 612
3 wooden drawers H 190



W 462	W 626	W 790	W 954	W 1282
CNT4/06PA	CNT6/06PA	CNT8/06PA	CNT9/06PA	CNT13/06PA

melamine	448	497	524	550	683
----------	-----	-----	-----	-----	-----

Drawer units floor standing or suspended

H 804
4 wooden drawers H 190



W 462	W 626	W 790	W 954	W 1282
CNT4/08PA	CNT6/08PA	CNT8/08PA	CNT9/08PA	CNT13/08PA

melamine	564	627	661	694	852
----------	-----	-----	-----	-----	-----

"Smart" handle

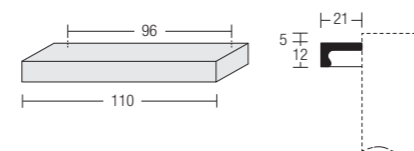

Vertical Internal LED Lighting

The vertical illumination can only be used on central or lateral wooden side panels.
Horizontal and vertical LEDs cannot be used in the same composition.
LED bars can be reduced without a supplementary charge.
Only 220V - Certifications C E

In the case of hinged doors with a lighting system, a minimum space measuring 5 cm in height is required. The height can be reduced to 15 mm by inspection on top cod. PAISPC01 € 157.

Vertical LED bars

H 2343	H 2439	H 2631	H 2919
16 watt	17 watt	18 watt	20 watt

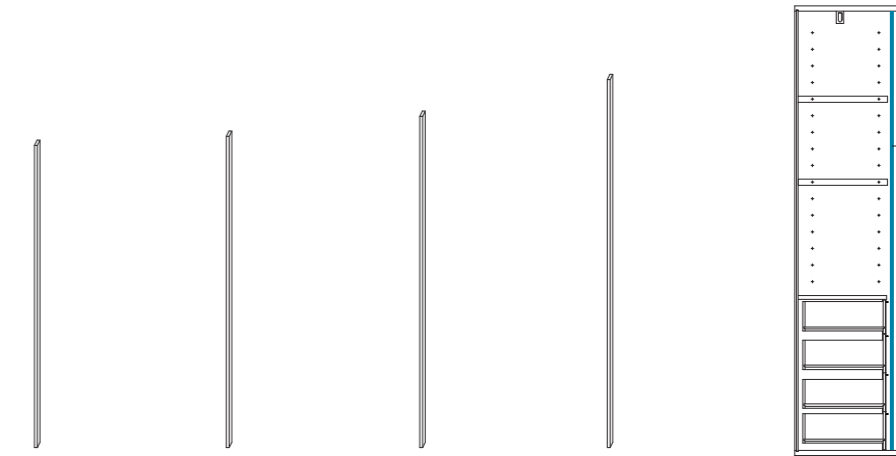

EVBA23	EVBA24	EVBA26	EVBA29
128	133	143	156

Components specifically for system with vertical LEDs

Power supply unit
50 watt, 75 watt, 100 watt

Sensor

Connector

Remote control with adjustment of light
1 per power supply unit

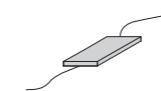

EVAL050

91

EVAL075

108

EVAL100

130



EVSE1

70



EVCO1

25



EVRA1

141

Diagram of LED lighting system for compartments with doors

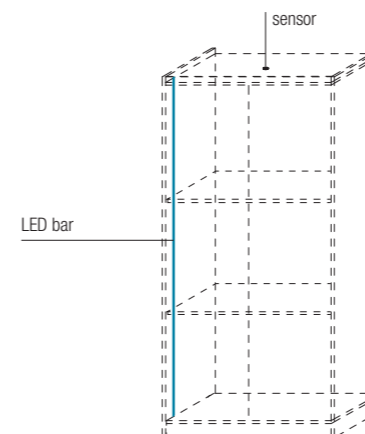

Components

- LED bar, 1 or 2 per compartment
- sensor, 1 per compartment
- power supply unit, 1 or 2 per wardrobe depending on total wattage
- connector, 1 per wardrobe

Diagram of LED lighting system for compartments without doors

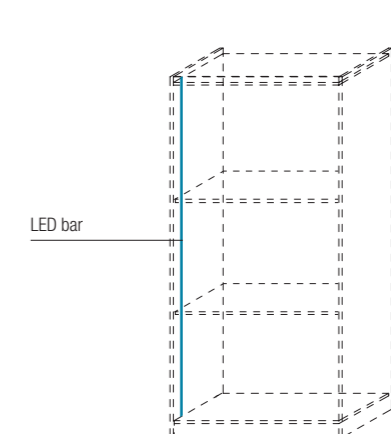

Components

- LED bar, 1 or 2 per compartment
- power supply unit, 1 or 2 per wardrobe depending on total wattage
- connector, 1 per wardrobe
- optional remote control, in the absence of a controlled socket
- optional sensor, in the absence of a controlled socket



Finished compositions H 2631

In addition to the standard elements necessary to build up any customized wardrobe, find below a number of pre-designed wardrobes H mm 2631.

Prices of the compositions are calculated with the external finish of the side panels in melamine structure and with standard handles without surcharge.

Backs are always in melamine.

The tatami and chestnut melamine finishes allow the creation of wardrobes with structures, side panels and doors in the same colour.

The price of wardrobes with TWIN doors always includes a handle in the pair of doors.

Wardrobes with START doors with "CV" handle available only with hinged opening.

Surcharge

Surcharge to be added to composition prices for different external side panels finishes.

Matt lacquer finish € 226 per pair

Glossy lacquer finish € 358 per pair

With external finish in wood, € 578 per pair

Surcharge handles

START door "M" handle € 47 each

GRIP door € 22 each



Assembly

Assembly of a wardrobe in an alcove requires a minimum extra side space of 4 cm. This space can be reduced to 15 mm by using special hardware provided on request for the side compartment. Surcharge € 40 per compartment. This hardware may only be applied if there are open compartments, hinged doors and wooden side panels.

For hinged door wardrobes with lighting systems doors this product requires a minimum height of 5 cm. The height can be reduced to 15 mm by inspection on top cod. PAISPC01 € 157.

MODULARITY

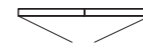
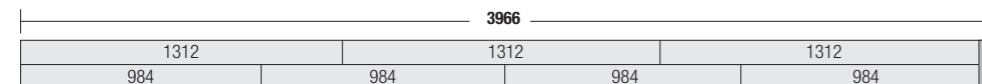
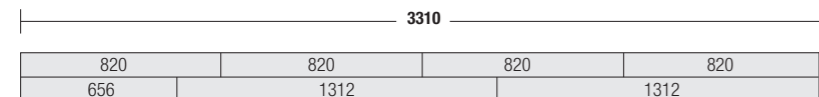
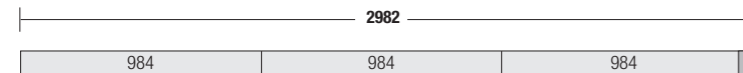
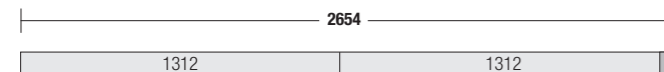
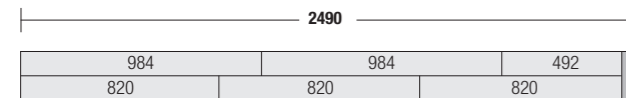
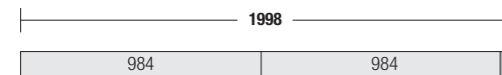
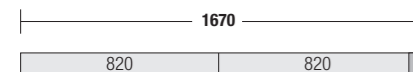

Compositions with hinged doors

1 page 16

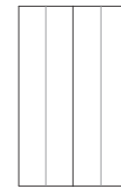

W 1670 mm

2 page 17

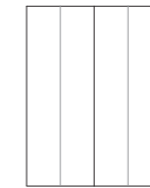

W 1998 mm

3 page 18

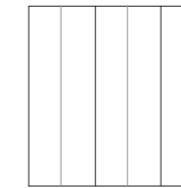

W 2490 mm

4 page 19

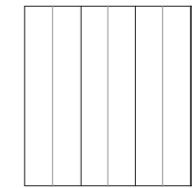

W 2490 mm

5 page 20

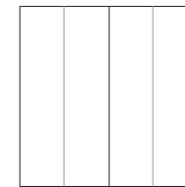

W 2654 mm

6 page 21

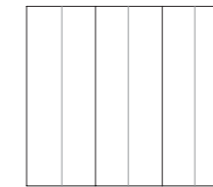

W 2982 mm

7 page 22

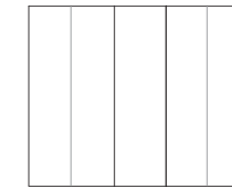

W 3310 mm

8 page 23

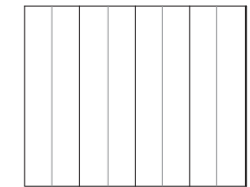

W 3310 mm

9 page 24

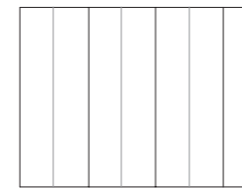

W 3474 mm

10 page 25



W 3966 mm

11 page 26

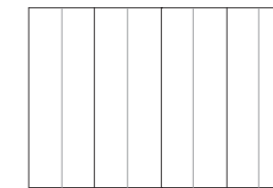

W 3966 mm

12 page 27



Corner



Compositions with sliding doors

13 page 28

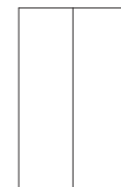

W 1670 mm

14 page 29

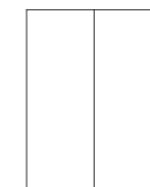

W 1998 mm

15 page 30

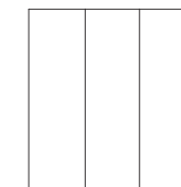

W 2490 mm

16 page 31

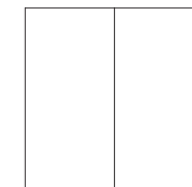

W 2654 mm

17 page 32

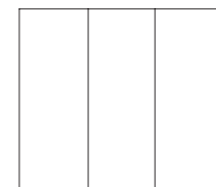

W 2982 mm

18 page 33

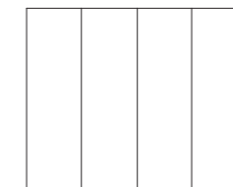

W 3310 mm

19 page 34



W 3966 mm

20 page 35

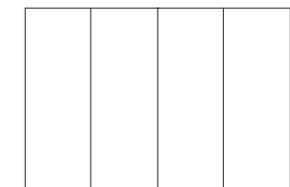

W 3966 mm

W 1670

modules 820 - 820

- For visible side panels with Cartapaglia and Silk melamine, Lunar and Glaze front, include the supplementary cost for matt lacquered side panels.
- Compositions with FIND-ME and HOLLOW doors are not available in every finish.
- **For custom reduction surcharges check on page 36**

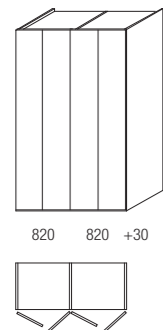

Structure with doors	QUICK	FIND-ME HOLLOW A FILO	SMOOTH	START TWIN	GRIP
	UB/A	FB/A	CB/A	SB/A	GB/A
melamine front	1.908	2.014		1.860	1.942
matt lacquer colours		2.280		2.120	2.206
vertical grain wood		3.222		3.062	3.154
Lunar (only FIND-ME)		3.336			
glossy lacquer colours		3.998		3.824	3.922
Glaze		4.498		4.426	
coloured/etched col. glass		3.582			
Eco Skin			4.458		

Internal fittings



A Complete fittings € 109

	Code	Q.ty	€
Wood shelves W 790	RI/8	1	57
"Smart" clothes rails W 790	PP/08	2	52

C Complete fittings € 614

	Code	Q.ty	€
Wood shelves W 790	RI/8	4	228
"Smart" drawer units 2 drawers W 790	CNT8/04PB	1	386

B Complete fittings € 607

	Code	Q.ty	€
Wood shelves W 790	RI/8	1	57
"Smart" clothes rails W 790	PP/08	1	26
"Smart" drawer units 3 drawers W 790	CNT8/06PA	1	524

D Complete fittings € 495

	Code	Q.ty	€
Wood shelves W 790	RI/8	1	57
"Smart" clothes rails W 790	PP/08	2	52
"Smart" drawer units 2 drawers W 790	CNT8/04PB	1	386

Lighting system complete with sensors power supply and connector

N.1 vertical LED bar each compartment	542	excluding remote control
N.2 vertical LED bars each compartment	845	excluding remote control

Additional elements

Code	€	Code	€
Wood shelf W 790	RI/8	57	
"Smart" clothes rails W 790	PP/08	26	
"Smart" drawer unit 2 drawers W 790	CNT8/04PB	386	
"Smart" drawer unit 3 drawers W 790	CNT8/06PA	524	
"Smart" drawer unit 4 drawers W 790	CNT8/08PA	661	
Supplementary cost for matt lacq. side panels	each couple	226	
Supplementary cost for glossy lacq. side panels	each couple	358	
Supplementary cost for wood side panels	each couple	578	
START door – extra charge for "M" handle	each.	47	
GRIP door – extra charge for Eco Skin version	each.	22	

W 1998

modules 984 - 984

- For visible side panels with Cartapaglia and Silk melamine, Lunar and Glaze front, include the supplementary cost for matt lacquered side panels.
- Compositions with FIND-ME and HOLLOW doors are not available in every finish.
- **For custom reduction surcharges check on page 36**

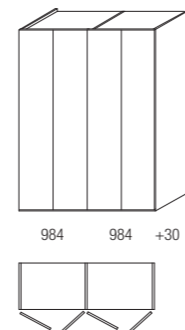

Structure with doors	QUICK	FIND-ME HOLLOW A FILO	SMOOTH	START TWIN	GRIP
	UB/B	FB/B	CB/B	SB/B	GB/B
melamine front	1.990	2.096		1.942	2.024
matt lacquer colours		2.362		2.202	2.288
vertical grain wood		3.304		3.144	3.236
Lunar (only FIND-ME)		3.418			
glossy lacquer colours		4.080		3.906	4.004
Glaze		4.580		4.508	
coloured/etched col. glass		3.664			
Eco Skin			4.658		

Internal fittings



A Complete fittings € 116

	Code	Q.ty	€
Wood shelves W 954	RI/9	1	60
"Smart" clothes rails W 954	PP/09	2	56

D Complete fittings € 521

	Code	Q.ty	€
Wood shelves W 954	RI/9	1	60
"Smart" clothes rails W 954	PP/09	2	56
"Smart" drawer units 2 drawers W 954	CNT9/04PB	1	405

B Complete fittings € 638

	Code	Q.ty	€
Wood shelves W 954	RI/9	1	60
"Smart" clothes rails W 954	PP/09	1	28
"Smart" drawer units 3 drawers W 954	CNT9/06PA	1	550

E Complete fittings € 335

	Code	Q.ty	€
Wood shelves W 954	RI/9	1	60
"Smart" clothes rails W 954	PP/09	1	28
Dividing panels H 1158	SDT/11	1	102
Wood shelves W 462	RI/4	3	123
"Smart" clothes rails W 462	PP/04	1	22

C Complete fittings € 645

	Code	Q.ty	€
Wood shelves W 954	RI/9	4	240
"Smart" drawer units 2 drawers W 954	CNT9/04PB	1	405

Lighting system complete with sensors power supply and connector

N.1 vertical LED bar each compartment	542	excluding remote control
N.2 vertical LED bars each compartment	845	excluding remote control

Additional elements

Code	€	Code	€
Wood shelf W 954	RI/9	60	
Wood shelf W 462	RI/4	41	
"Smart" clothes rails W 954	PP/09	28	
"Smart" clothes rails W 462	PP/04	22	
"Smart" drawer unit 2 drawers W 954	CNT9/04PB	405	
"Smart" drawer unit 3 drawers W 954	CNT9/06PA	550	
"Smart" drawer unit 4 drawers W 954	CNT9/08PA	694	
"Smart" drawer unit 2 drawers W 462	CNT4/04PB	331	
"Smart" drawer unit 3 drawers W 462	CNT4/06PA	448	
"Smart" drawer unit 4 drawers W 462	CNT4/08PA	564	
Supplementary cost for matt lacq. side panels	each couple	226	
Supplementary cost for glossy lacq. side panels	each couple	358	
Supplementary cost for wood side panels	each couple	578	
START door – extra charge for "M" handle	each.	47	
GRIP door – extra charge for Eco Skin version	each.	22	

W 2490

modules 984 - 984 - 492

- For visible side panels with Cartapaglia and Silk melamine, Lunar and Glaze front, include the supplementary cost for matt lacquered side panels.
- Compositions with FIND-ME and HOLLOW doors are not available in every finish.
- **For custom reduction surcharges check on page 36**

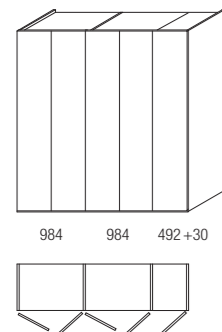

Structure with doors	QUICK	FIND-ME HOLLOW A FILO	SMOOTH	START TWIN	GRIP
	UB/Q	FB/Q	CB/Q	SB/Q	GB/Q
melamine front	2.570	2.729		2.498	2.580
matt lacquer colours		3.064		2.824	2.910
vertical grain wood		4.243		4.003	4.095
Lunar (only FIND-ME)		4.361			
glossy lacquer colours		5.218		4.957	5.055
Glaze		5.815		5.707	
coloured/etched col. glass		4.690			
Eco Skin			5.883		

Internal fittings

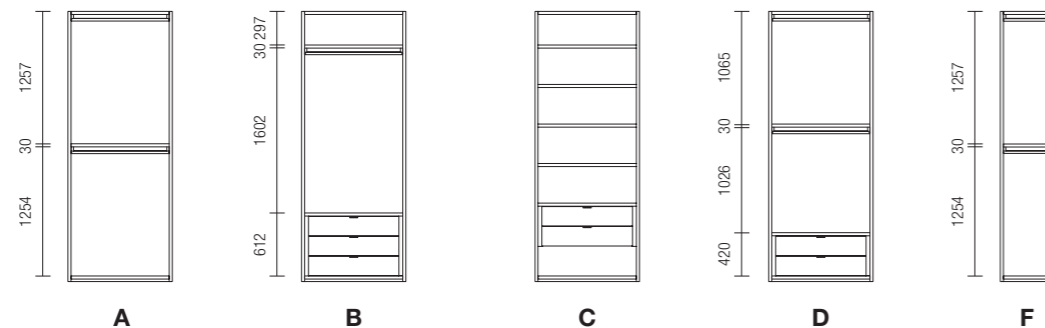

A Complete fittings € **116**

	Code	Q.ty	€
Wood shelves W 954	RI/9	1	60
"Smart" clothes rails W 954	PP/09	2	56

D Complete fittings € **521**

	Code	Q.ty	€
Wood shelves W 954	RI/9	1	60
"Smart" clothes rails W 954	PP/09	2	56
"Smart" drawer units 2 drawers W 954	CNT9/04PB	1	405

B Complete fittings € **638**

	Code	Q.ty	€
Wood shelves W 954	RI/9	1	60
"Smart" clothes rails W 954	PP/09	1	28
"Smart" drawer units 3 drawers W 954	CNT9/06PA	1	550

F Complete fittings € **85**

	Code	Q.ty	€
Wood shelves W 462	RI/4	1	41
"Smart" clothes rails W 462	PP/04	2	44

C Complete fittings € **645**

	Code	Q.ty	€
Wood shelves W 954	RI/9	4	240
"Smart" drawer units 2 drawers W 954	CNT9/04PB	1	405

Lighting system complete with sensors power supply and connector

N.1 vertical LED bar each compartment	772	excluding remote control
N.2 vertical LED bars each compartment W 984 + N.1 bar compartment W 492	1.080	excluding remote control

Additional elements	Code	€		Code	€
Wood shelf W 954	RI/9	60	"Smart" drawer unit 3 drawers W 462	CNT4/06PA	448
Wood shelf W 462	RI/4	41	"Smart" drawer unit 4 drawers W 462	CNT4/08PA	564
"Smart" clothes rails W 954	PP/09	28	Supplementary cost for matt lacq. side panels	each couple	226
"Smart" clothes rails W 462	PP/04	22	Supplementary cost for glossy lacq. side panels	each couple	358
"Smart" drawer unit 2 drawers W 954	CNT9/04PB	405	Supplementary cost for wood side panels	each couple	578
"Smart" drawer unit 3 drawers W 954	CNT9/06PA	550	START door – extra charge for "M" handle	each.	47
"Smart" drawer unit 4 drawers W 954	CNT9/08PA	694	GRIP door – extra charge for Eco Skin version	each.	22
"Smart" drawer unit 2 drawers W 462	CNT4/04PB	331			

W 2490

modules 820 - 820 - 820

- For visible side panels with Cartapaglia and Silk melamine, Lunar and Glaze front, include the supplementary cost for matt lacquered side panels.
- Compositions with FIND-ME and HOLLOW doors are not available in every finish.
- **For custom reduction surcharges check on page 36**

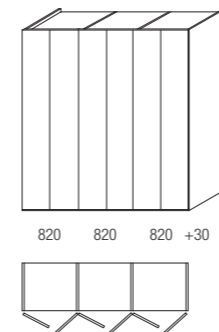

Structure with doors	QUICK	FIND-ME HOLLOW A FILO	SMOOTH	START TWIN	GRIP
	UB/D	FB/D	CB/D	SB/D	GB/D
melamine front	2.747	2.906		2.675	2.798
matt lacquer colours		3.305		3.065	3.194
vertical grain wood		4.718		4.478	4.616
Lunar (only FIND-ME)		4.889			
glossy lacquer colours		5.882		5.621	5.768
Glaze		6.632		6.524	
coloured/etched col. glass		5.258			
Eco Skin			6.572		

Internal fittings

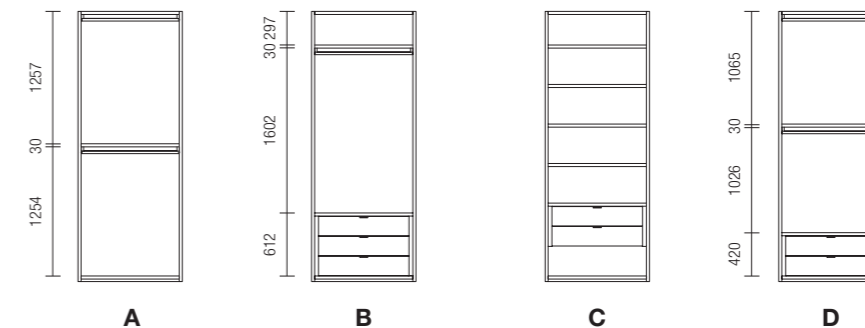

A Complete fittings € **109**

	Code	Q.ty	€
Wood shelves W 790	RI/8	1	57
"Smart" clothes rails W 790	PP/08	2	52

C Complete fittings € **614**

	Code	Q.ty	€
Wood shelves W 790	RI/8	4	228
"Smart" drawer units 2 drawers W 790	CNT8/04PB	1	386

B Complete fittings € **607**

	Code	Q.ty	€
Wood shelves W 790	RI/8	1	57
"Smart" clothes rails W 790	PP/08	1	26
"Smart" drawer units 3 drawers W 790	CNT8/06PA	1	524

D Complete fittings € **495**

	Code	Q.ty	€
Wood shelves W 790	RI/8	1	57
"Smart" clothes rails W 790	PP/08	2	52
"Smart" drawer units 2 drawers W 790	CNT8/04PB	1	386

Lighting system complete with sensors power supply and connector

N.1 vertical LED bar each compartment	772	excluding remote control
N.2 vertical LED bars each compartment	1.292	excluding remote control

Additional elements	Code	€		Code	€
Wood shelf W 790	RI/8	57	Supplementary cost for matt lacq. side panels	each couple	226
"Smart" clothes rails W 790	PP/08	26	Supplementary cost for glossy lacq. side panels	each couple	358
"Smart" drawer unit 2 drawers W 790	CNT8/04PB	386	Supplementary cost for wood side panels	each couple	578
"Smart" drawer unit 3 drawers W 790	CNT8/06PA	524	START door – extra charge for "M" handle	each.	47
"Smart" drawer unit 4 drawers W 790	CNT8/08PA	661	GRIP door – extra charge for Eco Skin version	each.	22

W 2654

modules 1312 - 1312

- For visible side panels with Cartapaglia and Silk melamine, Lunar and Glaze front, include the supplementary cost for matt lacquered side panels.
- Compositions with FIND-ME and HOLLOW doors are not available in every finish.
- **For custom reduction surcharges check on page 36**

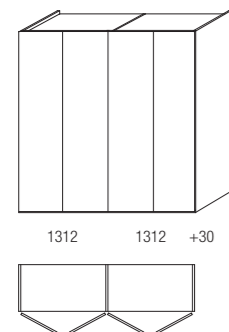

Structure with doors	QUICK	FIND-ME HOLLOW A FILO	SMOOTH	START TWIN	GRIP
	UB/E	FB/E	CB/E	SB/E	GB/E
melamine front	2.172	2.278		2.124	2.208
matt lacquer colours		2.748		2.544	2.632
vertical grain wood		3.968		3.806	3.892
Lunar (only FIND-ME)		4.062			
glossy lacquer colours		5.240		5.068	5.172
Glaze		5.574		5.502	
coloured/etched col. glass		4.078			
Eco Skin			5.044		

Internal fittings



A Complete fittings € 159	Code	Q.ty	€
Wood shelves W 1282	RI/13	1	77
"Smart" clothes rails W 1282	PP/13	2	82

B Complete fittings € 801	Code	Q.ty	€
Wood shelves W 1282	RI/13	1	77
"Smart" clothes rails W 1282	PP/13	1	41
"Smart" drawer units 3 drawers W 1282	CNT13/06PA	1	683

C Complete fittings € 821	Code	Q.ty	€
Wood shelves W 1282	RI/13	4	308
"Smart" drawer units 2 drawers W 1282	CNT13/04PB	1	513

D Complete fittings € 672	Code	Q.ty	€
Wood shelves W 1282	RI/13	1	77
"Smart" clothes rails W 1282	PP/13	2	82
"Smart" drawer units 2 drawers W 1282	CNT13/04PB	1	513

E Complete fittings € 397	Code	Q.ty	€
Wood shelves W 1282	RI/13	1	77
"Smart" clothes rails W 1282	PP/13	1	41
Dividing panels H 1158	SDT/11	1	102
Wood shelves W 626	RI/6	3	153
"Smart" clothes rails W 626	PP/06	1	24

Lighting system complete with sensors power supply and connector

N.1 vertical LED bar each compartment	542	excluding remote control
N.2 vertical LED bars each compartment	845	excluding remote control

Additional elements	Code	€	Code	€
Wood shelf W 1282	RI/13	77	"Smart" drawer unit 3 drawers W 626	CNT6/06PA 497
Wood shelf W 626	RI/6	51	"Smart" drawer unit 4 drawers W 626	CNT6/08PA 627
"Smart" clothes rails W 1282	PP/13	41	Supplementary cost for matt lacq. side panels	each couple 226
"Smart" clothes rails W 626	PP/06	24	Supplementary cost for glossy lacq. side panels	each couple 358
"Smart" drawer unit 2 drawers W 1282	CNT13/04PB	513	Supplementary cost for wood side panels	each couple 578
"Smart" drawer unit 3 drawers W 1282	CNT13/06PA	683	START door – extra charge for "M" handle	each. 47
"Smart" drawer unit 4 drawers W 1282	CNT13/08PA	852	GRIP door – extra charge for Eco Skin version	each. 22
"Smart" drawer unit 2 drawers W 626	CNT6/04PB	366		

W 2982

modules 984 - 984 - 984

- For visible side panels with Cartapaglia and Silk melamine, Lunar and Glaze front, include the supplementary cost for matt lacquered side panels.
- Compositions with FIND-ME and HOLLOW doors are not available in every finish.
- **For custom reduction surcharges check on page 36**

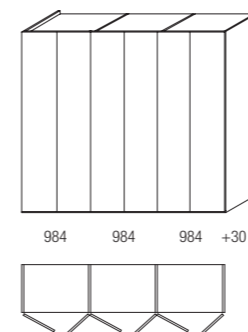

Structure with doors	QUICK	FIND-ME HOLLOW A FILO	SMOOTH	START TWIN	GRIP
	UB/G	FB/G	CB/G	SB/G	GB/G
melamine front	2.870	3.029		2.798	2.921
matt lacquer colours		3.428		3.188	3.317
vertical grain wood		4.841		4.601	4.739
Lunar (only FIND-ME)		5.012			
glossy lacquer colours		6.005		5.744	5.891
Glaze		6.755		6.647	
coloured/etched col. glass		5.381			
Eco Skin			6.872		

Internal fittings



A Complete fittings € 116	Code	Q.ty	€
Wood shelves W 954	RI/9	1	60
"Smart" clothes rails W 954	PP/09	2	56

B Complete fittings € 638	Code	Q.ty	€
Wood shelves W 954	RI/9	1	60
"Smart" clothes rails W 954	PP/09	1	28
"Smart" drawer units 3 drawers W 954	CNT9/06PA	1	550

C Complete fittings € 645	Code	Q.ty	€
Wood shelves W 954	RI/9	4	240
"Smart" drawer units 2 drawers W 954	CNT9/04PB	1	405

D Complete fittings € 521	Code	Q.ty	€
Wood shelves W 954	RI/9	1	60
"Smart" clothes rails W 954	PP/09	2	56
"Smart" drawer units 2 drawers W 954	CNT9/04PB	1	405

E Complete fittings € 335	Code	Q.ty	€
Wood shelves W 954	RI/9	1	60
"Smart" clothes rails W 954	PP/09	1	28
Dividing panels H 1158	SDT/11	1	102
Wood shelves W 462	RI/4	3	123
"Smart" clothes rails W 462	PP/04	1	22

Lighting system complete with sensors power supply and connector

N.1 vertical LED bar each compartment	772	excluding remote control
N.2 vertical LED bars each compartment	1.292	excluding remote control

Additional elements	Code	€	Code	€
Wood shelf W 954	RI/9	60	"Smart" drawer unit 3 drawers W 462	CNT4/06PA 448
Wood shelf W 462	RI/4	41	"Smart" drawer unit 4 drawers W 462	CNT4/08PA 564
"Smart" clothes rails W 954	PP/09	28	Supplementary cost for matt lacq. side panels	each couple 226
"Smart" clothes rails W 462	PP/04	22	Supplementary cost for glossy lacq. side panels	each couple 358
"Smart" drawer unit 2 drawers W 954	CNT9/04PB	405	Supplementary cost for wood side panels	each couple 578
"Smart" drawer unit 3 drawers W 954	CNT9/06PA	550	START door – extra charge for "M" handle	each. 47
"Smart" drawer unit 4 drawers W 954	CNT9/08PA	694	GRIP door – extra charge for Eco Skin version	each. 22
"Smart" drawer unit 2 drawers W 462	CNT4/04PB	331		

W 3310

modules 1312 - 656 - 1312

- For visible side panels with Cartapaglia and Silk melamine, Lunar and Glaze front, include the supplementary cost for matt lacquered side panels.
- Compositions with FIND-ME and HOLLOW doors are not available in every finish.
- **For custom reduction surcharges check on page 36**

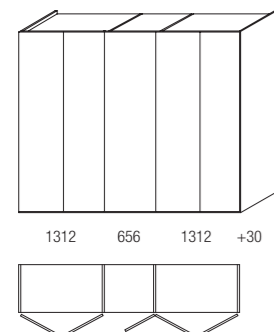

Structure with doors	QUICK	FIND-ME HOLLOW A FILO	SMOOTH	START TWIN	GRIP
	UB/I	FB/I	CB/I	SB/I	GB/I
melamine front	2.803	2.962		2.731	2.815
matt lacquer colours		3.552		3.257	3.345
vertical grain wood		5.077		4.834	4.920
Lunar (only FIND-ME)		5.177			
glossy lacquer colours		6.674		6.416	6.520
Glaze		7.062		6.954	
coloured/etched col. glass		5.212			
Eco Skin			6.371		

Internal fittings



A Complete fittings € **159**

	Code	Q.ty	€
Wood shelves W 1282	RI/13	1	77
"Smart" clothes rails W 1282	PP/13	2	82

D Complete fittings € **672**

	Code	Q.ty	€
Wood shelves W 1282	RI/13	1	77
"Smart" clothes rails W 1282	PP/13	2	82
"Smart" drawer units 2 drawers W 1282	CNT13/04PB	1	513

B Complete fittings € **801**

	Code	Q.ty	€
Wood shelves W 1282	RI/13	1	77
"Smart" clothes rails W 1282	PP/13	1	41
"Smart" drawer units 3 drawers W 1282	CNT13/06PA	1	683

F Complete fittings € **99**

	Code	Q.ty	€
Wood shelves W 626	RI/6	1	51
"Smart" clothes rails W 626	PP/06	2	48

C Complete fittings € **821**

	Code	Q.ty	€
Wood shelves W 1282	RI/13	4	308
"Smart" drawer units 2 drawers W 1282	CNT13/04PB	1	513

Lighting system complete with sensors power supply and connector

N.1 vertical LED bar each compartment	772	excluding remote control
N.2 vertical LED bars each compartment W 1312 + N.1 bar compartment W 656	1.080	excluding remote control

Additional elements	Code	€		Code	€
Wood shelf W 1282	RI/13	77	"Smart" drawer unit 3 drawers W 626	CNT6/06PA	497
Wood shelf W 626	RI/6	51	"Smart" drawer unit 4 drawers W 626	CNT6/08PA	627
"Smart" clothes rails W 1282	PP/13	41	Supplementary cost for matt lacq. side panels	each couple	226
"Smart" clothes rails W 626	PP/06	24	Supplementary cost for glossy lacq. side panels	each couple	358
"Smart" drawer unit 2 drawers W 1282	CNT13/04PB	513	Supplementary cost for wood side panels	each couple	578
"Smart" drawer unit 3 drawers W 1282	CNT13/06PA	683	START door – extra charge for "M" handle	each.	47
"Smart" drawer unit 4 drawers W 1282	CNT13/08PA	852	GRIP door – extra charge for Eco Skin version	each.	22
"Smart" drawer unit 2 drawers W 626	CNT6/04PB	366			

W 3310

modules 820 - 820 - 820 - 820

- For visible side panels with Cartapaglia and Silk melamine, Lunar and Glaze front, include the supplementary cost for matt lacquered side panels.
- Compositions with FIND-ME and HOLLOW doors are not available in every finish.
- **For custom reduction surcharges check on page 36**

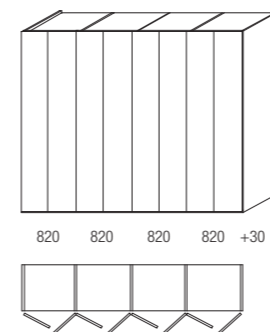

Structure with doors	QUICK	FIND-ME HOLLOW A FILO	SMOOTH	START TWIN	GRIP
	UB/J	FB/J	CB/J	SB/J	GB/J
melamine front	3.586	3.798		3.490	3.654
matt lacquer colours		4.330		4.010	4.182
vertical grain wood		6.214		5.894	6.078
Lunar (only FIND-ME)		6.442			
glossy lacquer colours		7.766		7.418	7.614
Glaze		8.766		8.622	
coloured/etched col. glass		6.934			
Eco Skin			8.686		

Internal fittings

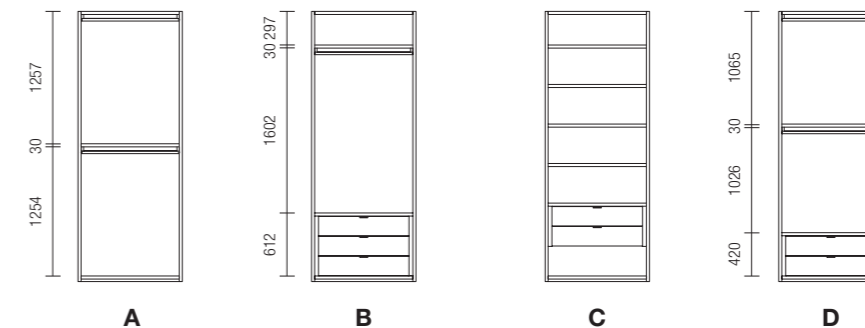

A Complete fittings € **109**

	Code	Q.ty	€
Wood shelves W 790	RI/8	1	57
"Smart" clothes rails W 790	PP/08	2	52

C Complete fittings € **614**

	Code	Q.ty	€
Wood shelves W 790	RI/8	4	228
"Smart" drawer units 2 drawers W 790	CNT8/04PB	1	386

B Complete fittings € **607**

	Code	Q.ty	€
Wood shelves W 790	RI/8	1	57
"Smart" clothes rails W 790	PP/08	1	26
"Smart" drawer units 3 drawers W 790	CNT8/06PA	1	524

D Complete fittings € **495**

	Code	Q.ty	€
Wood shelves W 790	RI/8	1	57
"Smart" clothes rails W 790	PP/08	2	52
"Smart" drawer units 2 drawers W 790	CNT8/04PB	1	386

Lighting system complete with sensors power supply and connector

N.1 vertical LED bar each compartment	985	excluding remote control
N.2 vertical LED bars each compartment	1.665	excluding remote control

Additional elements	Code	€		Code	€
Wood shelf W 790	RI/8	57	Supplementary cost for matt lacq. side panels	each couple	226
"Smart" clothes rails W 790	PP/08	26	Supplementary cost for glossy lacq. side panels	each couple	358
"Smart" drawer unit 2 drawers W 790	CNT8/04PB	386	Supplementary cost for wood side panels	each couple	578
"Smart" drawer unit 3 drawers W 790	CNT8/06PA	524	START door – extra charge for "M" handle	each.	47
"Smart" drawer unit 4 drawers W 790	CNT8/08PA	661	GRIP door – extra charge for Eco Skin version	each.	22

W 3474

modules 984 - 984 - 984 - 492 - 492

- For visible side panels with Cartapaglia and Silk melamine, Lunar and Glaze front, include the supplementary cost for matt lacquered side panels.
- Compositions with FIND-ME and HOLLOW doors are not available in every finish.
- **For custom reduction surcharges check on page 36**

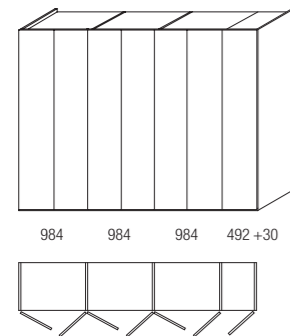

Structure with doors	QUICK	FIND-ME HOLLOW A FILO	SMOOTH	START TWIN	GRIP
	UB/R	FB/R	CB/R	SB/R	GB/R
melamine front	3.450	3.662		3.354	3.477
matt lacquer colours		4.130		3.810	3.939
vertical grain wood		5.780		5.460	5.598
Lunar (only FIND-ME)		5.955			
glossy lacquer colours		7.143		6.795	6.942
Glaze		7.990		7.846	
coloured/etched col. glass		6.407			
Eco Skin			8.097		

Internal fittings

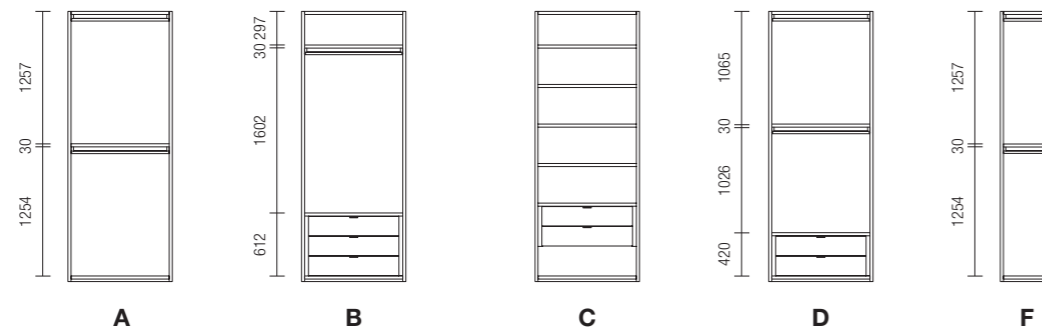

A Complete fittings € 116	Code	Q.ty	€
Wood shelves W 954	RI/9	1	60
"Smart" clothes rails W 954	PP/09	2	56

B Complete fittings € 638	Code	Q.ty	€
Wood shelves W 954	RI/9	1	60
"Smart" clothes rails W 954	PP/09	1	28
"Smart" drawer units 3 drawers W 954	CNT9/06PA	1	550

C Complete fittings € 645	Code	Q.ty	€
Wood shelves W 954	RI/9	4	240
"Smart" drawer units 2 drawers W 954	CNT9/04PB	1	405

D Complete fittings € 521	Code	Q.ty	€
Wood shelves W 954	RI/9	1	60
"Smart" clothes rails W 954	PP/09	2	56
"Smart" drawer units 2 drawers W 954	CNT9/04PB	1	405

F Complete fittings € 85	Code	Q.ty	€
Wood shelves W 462	RI/4	1	41
"Smart" clothes rails W 462	PP/04	2	44

Lighting system complete with sensors power supply and connector

N.1 vertical LED bar each compartment	985	excluding remote control
N.2 vertical LED bars each compartment W 984 + N.1 bar compartment W 492	1.522	excluding remote control

Additional elements	Code	€	Additional elements	Code	€
Wood shelf W 954	RI/9	60	"Smart" drawer unit 3 drawers W 462	CNT4/06PA	448
Wood shelf W 462	RI/4	41	"Smart" drawer unit 4 drawers W 462	CNT4/08PA	564
"Smart" clothes rails W 954	PP/09	28	Supplementary cost for matt lacq. side panels	each couple	226
"Smart" clothes rails W 462	PP/04	22	Supplementary cost for glossy lacq. side panels	each couple	358
"Smart" drawer unit 2 drawers W 954	CNT9/04PB	405	Supplementary cost for wood side panels	each couple	578
"Smart" drawer unit 3 drawers W 954	CNT9/06PA	550	START door – extra charge for "M" handle	each.	47
"Smart" drawer unit 4 drawers W 954	CNT9/08PA	694	GRIP door – extra charge for Eco Skin version	each.	22
"Smart" drawer unit 2 drawers W 462	CNT4/04PB	331			

W 3966

modules 1312 - 1312 - 1312

- For visible side panels with Cartapaglia and Silk melamine, Lunar and Glaze front, include the supplementary cost for matt lacquered side panels.
- Compositions with FIND-ME and HOLLOW doors are not available in every finish.
- **For custom reduction surcharges check on page 36**

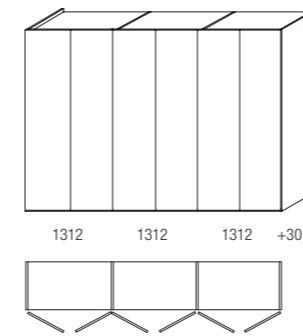

Structure with doors	QUICK	FIND-ME HOLLOW A FILO	SMOOTH	START TWIN	GRIP
	UB/O	FB/O	CB/O	SB/O	GB/O
melamine front	3.143	3.302		3.071	3.197
matt lacquer colours		4.007		3.701	3.833
vertical grain wood		5.837		5.594	5.723
Lunar (only FIND-ME)		5.978			
glossy lacquer colours		7.745		7.487	7.643
Glaze		8.246		8.138	
coloured/etched col. glass		6.002			
Eco Skin			7.451		

Internal fittings

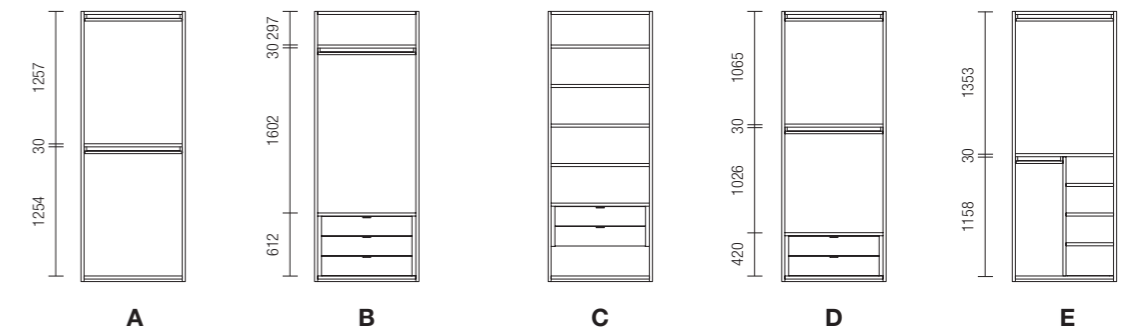

A Complete fittings € 159	Code	Q.ty	€
Wood shelves W 1282	RI/13	1	77
"Smart" clothes rails W 1282	PP/13	2	82

B Complete fittings € 801	Code	Q.ty	€
Wood shelves W 1282	RI/13	1	77
"Smart" clothes rails W 1282	PP/13	1	41
"Smart" drawer units 3 drawers W 1282	CNT13/06PA	1	683

C Complete fittings € 821	Code	Q.ty	€
Wood shelves W 1282	RI/13	4	308
"Smart" drawer units 2 drawers W 1282	CNT13/04PB	1	513

D Complete fittings € 672	Code	Q.ty	€
Wood shelves W 1282	RI/13	1	77
"Smart" clothes rails W 1282	PP/13	2	82
"Smart" drawer units 2 drawers W 1282	CNT13/04PB	1	513

E Complete fittings € 397	Code	Q.ty	€
Wood shelves W 1282	RI/13	1	77
"Smart" clothes rails W 1282	PP/13	1	41
Dividing panels H 1158	SDT/11	1	102
Wood shelves W 626	RI/6	3	153
"Smart" clothes rails W 626	PP/06	1	24

Lighting system complete with sensors power supply and connector

N.1 vertical LED bar each compartment	772	excluding remote control
N.2 vertical LED bars each compartment	1.292	excluding remote control

Additional elements	Code	€	Additional elements	Code	€
Wood shelf W 1282	RI/13	77	"Smart" drawer unit 3 drawers W 626	CNT6/06PA	497
Wood shelf W 626	RI/6	51	"Smart" drawer unit 4 drawers W 626	CNT6/08PA	627
"Smart" clothes rails W 1282	PP/13	41	Supplementary cost for matt lacq. side panels	each couple	226
"Smart" clothes rails W 626	PP/06	24	Supplementary cost for glossy lacq. side panels	each couple	358
"Smart" drawer unit 2 drawers W 1282	CNT13/04PB	513	Supplementary cost for wood side panels	each couple	578
"Smart" drawer unit 3 drawers W 1282	CNT13/06PA	683	START door – extra charge for "M" handle	each.	47
"Smart" drawer unit 4 drawers W 1282	CNT13/08PA	852	GRIP door – extra charge for Eco Skin version	each.	22
"Smart" drawer unit 2 drawers W 626	CNT6/04PB	366			

W 3966

modules 984 - 984 - 984 - 984

- For visible side panels with Cartapaglia and Silk melamine, Lunar and Glaze front, include the supplementary cost for matt lacquered side panels.
- Compositions with FIND-ME and HOLLOW doors are not available in every finish.
- **For custom reduction surcharges check on page 36**

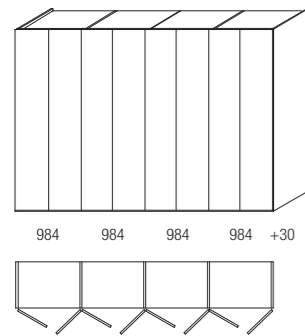

Structure with doors	QUICK	FIND-ME HOLLOW A FILO	SMOOTH	START TWIN	GRIP
	UB/P	FB/P	CB/P	SB/P	GB/P
melamine front	3.750	3.962		3.654	3.818
matt lacquer colours		4.994		4.174	4.346
vertical grain wood		6.378		6.058	6.242
Lunar (only FIND-ME)		6.606			
glossy lacquer colours		7.930		7.582	7.778
Glaze		8.930		8.786	
coloured/etched col. glass		7.098			
Eco Skin			9.086		

Internal fittings

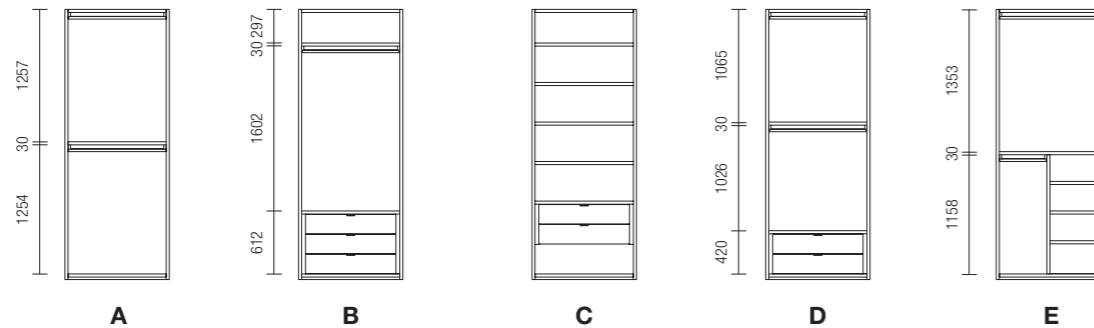

A Complete fittings € **116**

	Code	Q.ty	€
Wood shelves W 954	RI/9	1	60
"Smart" clothes rails W 954	PP/09	2	56

D Complete fittings € **521**

	Code	Q.ty	€
Wood shelves W 954	RI/9	1	60
"Smart" clothes rails W 954	PP/09	2	56
"Smart" drawer units 2 drawers W 954	CNT9/04PB	1	405

B Complete fittings € **638**

	Code	Q.ty	€
Wood shelves W 954	RI/9	1	60
"Smart" clothes rails W 954	PP/09	1	28
"Smart" drawer units 3 drawers W 954	CNT9/06PA	1	550

E Complete fittings € **335**

	Code	Q.ty	€
Wood shelves W 954	RI/9	1	60
"Smart" clothes rails W 954	PP/09	1	28
Dividing panels H 1158	SDT/11	1	102
Wood shelves W 462	RI/4	3	123
"Smart" clothes rails W 462	PP/04	1	22

C Complete fittings € **645**

	Code	Q.ty	€
Wood shelves W 954	RI/9	4	240
"Smart" drawer units 2 drawers W 954	CNT9/04PB	1	405

Lighting system complete with sensors power supply and connector

N.1 vertical LED bar each compartment	985	excluding remote control
N.2 vertical LED bars each compartment	1.665	excluding remote control

Additional elements	Code	€	Additional elements	Code	€
Wood shelf W 954	RI/9	60	"Smart" drawer unit 3 drawers W 462	CNT4/06PA	448
Wood shelf W 462	RI/4	41	"Smart" drawer unit 4 drawers W 462	CNT4/08PA	564
"Smart" clothes rails W 954	PP/09	28	Supplementary cost for matt lacq. side panels	each couple	226
"Smart" clothes rails W 462	PP/04	22	Supplementary cost for glossy lacq. side panels	each couple	358
"Smart" drawer unit 2 drawers W 954	CNT9/04PB	405	Supplementary cost for wood side panels	each couple	578
"Smart" drawer unit 3 drawers W 954	CNT9/06PA	550	START door – extra charge for "M" handle	each.	47
"Smart" drawer unit 4 drawers W 954	CNT9/08PA	694	GRIP door – extra charge for Eco Skin version	each.	22
"Smart" drawer unit 2 drawers W 462	CNT4/04PB	331			

W 3099 / W 1131

modules 984 - 984 - 1101 - 1101

W 2115 / W 2115

modules 984 - 1101 - 1101 - 984

- For visible side panels with Cartapaglia and Silk melamine and Glaze front, include the supplementary cost for matt lacquered side panels.
- **For custom reduction surcharges check on page 36**

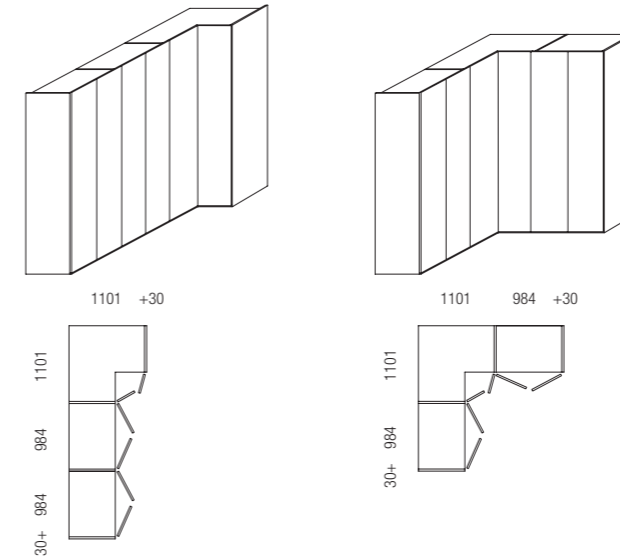

Structure with doors	QUICK	A FILO
	UB/S	FB/S
melamine front	3.713	3.872
matt lacquer colours		4.322
vertical grain wood		5.806
glossy lacquer colours		7.092
Glaze		7.802
coloured/etched col. glass		6.283

Internal fittings



A Complete fittings € **116**

	Code	Q.ty	€
Wood shelves W 954	RI/9	1	60
"Smart" clothes rails W 954	PP/09	2	56

D Complete fittings € **521**

	Code	Q.ty	€
Wood shelves W 954	RI/9	1	60
"Smart" clothes rails W 954	PP/09	2	56
"Smart" drawer units 2 drawers W 954	CNT9/04PB	1	405

B Complete fittings € **638**

	Code	Q.ty	€
Wood shelves W 954	RI/9	1	60
"Smart" clothes rails W 954	PP/09	1	28
"Smart" drawer units 3 drawers W 954	CNT9/06PA	1	550

Corner Complete fittings € **268**

	Code	Q.ty	€
Corner shelf 1081 x 1081	RIA/11	1	134
Clothes rails short side			
"Smart" corner element W 543	PPA/05	2	52
Clothes rails long side			
"Smart" corner element W 1081	PPA/11	2	82

C Complete fittings € **645**

	Code	Q.ty	€
Wood shelves W 954	RI/9	4	240
"Smart" drawer units 2 drawers W 954	CNT9/04PB	1	405

Lighting system complete with sensors power supply and connector

N.1 vertical LED bar for linear compartments + N.2 LED bars for corner compartment	730	excluding remote control
N.2 vertical LED bars each compartment	1.031	excluding remote control

Additional elements	Code	€	Additional elements	Code	€
Wood shelf W 954	RI/9	60	"Smart" drawer unit 2 drawers W 954	CNT9/04PB	405
Corner shelf 1081 x 1081	RIA/11	134	"Smart" drawer unit 3 drawers W 954	CNT9/06PA	550
"Smart" clothes rails W 954	PP/09	28	"Smart" drawer unit 4 drawers W 954	CNT9/08PA	694
Clothes rails short side			Supplementary cost for matt lacq. side panels	each couple	226
"Smart" corner element W 543	PPA/05	26	Supplementary cost for glossy lacq. side panels	each couple	358
Clothes rails long side			Supplementary cost for wood side panels	each couple	578
"Smart" corner element W 1081	PPA/11	41			

W 1670
modules 820 - 820

- For visible side panels with Cartapaglia and Silk melamine front, include the supplementary cost for matt lacquered side panels.
- For custom reduction surcharges check on page 36

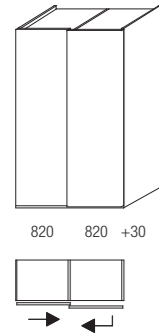

	QUICK	A FILO	BLADE	START	GRIP
Structure with doors	US/A	FS/A	BS/A	SS/A	GS/A
melamine front	2.300	2.407	2.407	2.254	2.254
matt lacquer colours		2.690	2.690	2.533	2.533
vertical grain wood		3.495	3.495	3.334	3.334
glossy lacquer colours		4.039	4.039	3.867	3.867
coloured/etched col. glass		4.273			

Internal fittings

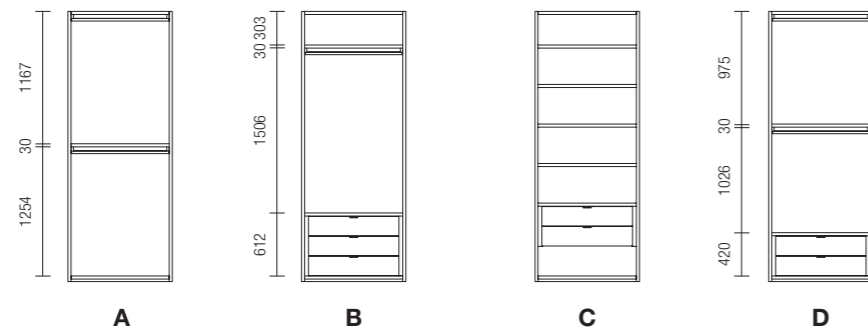

A Complete fittings € **109**

	Code	Q.ty	€
Wood shelves W 790	RI/8	1	57
"Smart" clothes rails W 790	PP/08	2	52

C Complete fittings € **614**

	Code	Q.ty	€
Wood shelves W 790	RI/8	4	228
"Smart" drawer units 2 drawers W 790	CNT8/04PB	1	386

B Complete fittings € **607**

	Code	Q.ty	€
Wood shelves W 790	RI/8	1	57
"Smart" clothes rails W 790	PP/08	1	26
"Smart" drawer units 3 drawers W 790	CNT8/06PA	1	524

D Complete fittings € **495**

	Code	Q.ty	€
Wood shelves W 790	RI/8	1	57
"Smart" clothes rails W 790	PP/08	2	52
"Smart" drawer units 2 drawers W 790	CNT8/04PB	1	386

Lighting system complete with sensors power supply and connector

N.1 vertical LED bar each compartment	542	excluding remote control
N.2 vertical LED bars each compartment	845	excluding remote control

Additional elements	Code	€	Code	€
Wood shelf W 790	RI/8	57	Supplementary cost for matt lacq. side panels	each couple 226
"Smart" clothes rails W 790	PP/08	26	Supplementary cost for glossy lacq. side panels	each couple 358
"Smart" drawer unit 2 drawers W 790	CNT8/04PB	386	Supplementary cost for wood side panels	each couple 578
"Smart" drawer unit 3 drawers W 790	CNT8/06PA	524	START door – extra charge for "M" handle	each. 47
"Smart" drawer unit 4 drawers W 790	CNT8/08PA	661	GRIP door – extra charge for Eco Skin version	each. 22

W 1998
modules 984 - 984

- For visible side panels with Cartapaglia and Silk melamine front, include the supplementary cost for matt lacquered side panels.
- For custom reduction surcharges check on page 36

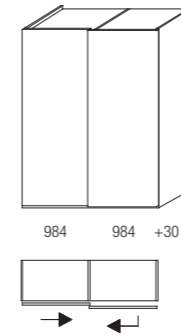

	QUICK	A FILO	BLADE	START	GRIP
Structure with doors	US/B	FS/B	BS/B	SS/B	GS/B
melamine front	2.427	2.535	2.535	2.380	2.380
matt lacquer colours		2.825	2.825	2.664	2.664
vertical grain wood		3.790	3.790	3.627	3.627
glossy lacquer colours		4.310	4.310	4.138	4.138
coloured/etched col. glass		4.523			

Internal fittings



A Complete fittings € **116**

	Code	Q.ty	€
Wood shelves W 954	RI/9	1	60
"Smart" clothes rails W 954	PP/09	2	56

D Complete fittings € **521**

	Code	Q.ty	€
Wood shelves W 954	RI/9	1	60
"Smart" clothes rails W 954	PP/09	2	56
"Smart" drawer units 2 drawers W 954	CNT9/04PB	1	405

B Complete fittings € **638**

	Code	Q.ty	€
Wood shelves W 954	RI/9	1	60
"Smart" clothes rails W 954	PP/09	1	28
"Smart" drawer units 3 drawers W 954	CNT9/06PA	1	550

E Complete fittings € **335**

	Code	Q.ty	€
Wood shelves W 954	RI/9	1	60
"Smart" clothes rails W 954	PP/09	1	28
Dividing panels H 1158	SDT/11	1	102
Wood shelves W 462	RI/4	3	123
"Smart" clothes rails W 462	PP/04	1	22

C Complete fittings € **645**

	Code	Q.ty	€
Wood shelves W 954	RI/9	4	240
"Smart" drawer units 2 drawers W 954	CNT9/04PB	1	405

Lighting system complete with sensors power supply and connector

N.1 vertical LED bar each compartment	542	excluding remote control
N.2 vertical LED bars each compartment	845	excluding remote control

Additional elements	Code	€	Code	€
Wood shelf W 954	RI/9	60	"Smart" drawer unit 3 drawers W 462	CNT4/06PA 448
Wood shelf W 462	RI/4	41	"Smart" drawer unit 4 drawers W 462	CNT4/08PA 564
"Smart" clothes rails W 954	PP/09	28	Supplementary cost for matt lacq. side panels	each couple 226
"Smart" clothes rails W 462	PP/04	22	Supplementary cost for glossy lacq. side panels	each couple 358
"Smart" drawer unit 2 drawers W 954	CNT9/04PB	405	Supplementary cost for wood side panels	each couple 578
"Smart" drawer unit 3 drawers W 954	CNT9/06PA	550	START door – extra charge for "M" handle	each. 47
"Smart" drawer unit 4 drawers W 954	CNT9/08PA	694	GRIP door – extra charge for Eco Skin version	each. 22
"Smart" drawer unit 2 drawers W 462	CNT4/04PB	331		

W 2490

modules 820 - 820 - 820

- For visible side panels with Cartapaglia and Silk melamine front, include the supplementary cost for matt lacquered side panels.
- For custom reduction surcharges check on page 36



	QUICK	A FILO	BLADE	START	GRIP
Structure with doors	US/C	FS/C	BS/C	SS/C	GS/C
melamine front	3.318	3.479	3.479	3.249	3.249
matt lacquer colours		3.903	3.903	3.666	3.666
vertical grain wood		5.110	5.110	4.868	4.868
glossy lacquer colours		5.922	5.922	5.664	5.664
coloured/etched col. glass		6.282			

Internal fittings



A Complete fittings € **109**

	Code	Q.ty	€
Wood shelves W 790	RI/8	1	57
"Smart" clothes rails W 790	PP/08	2	52

C Complete fittings € **614**

	Code	Q.ty	€
Wood shelves W 790	RI/8	4	228
"Smart" drawer units 2 drawers W 790	CNT8/04PB	1	386

B Complete fittings € **607**

	Code	Q.ty	€
Wood shelves W 790	RI/8	1	57
"Smart" clothes rails W 790	PP/08	1	26
"Smart" drawer units 3 drawers W 790	CNT8/06PA	1	524

D Complete fittings € **495**

	Code	Q.ty	€
Wood shelves W 790	RI/8	1	57
"Smart" clothes rails W 790	PP/08	2	52
"Smart" drawer units 2 drawers W 790	CNT8/04PB	1	386

Lighting system complete with sensors power supply and connector

N.1 vertical LED bar each compartment	772	excluding remote control
N.2 vertical LED bars each compartment	1.292	excluding remote control

Additional elements

Code	€	Code	€
Wood shelf W 790	RI/8	57	
"Smart" clothes rails W 790	PP/08	26	
"Smart" drawer unit 2 drawers W 790	CNT8/04PB	386	
"Smart" drawer unit 3 drawers W 790	CNT8/06PA	524	
"Smart" drawer unit 4 drawers W 790	CNT8/08PA	661	
Supplementary cost for matt lacq. side panels	each couple	226	
Supplementary cost for glossy lacq. side panels	each couple	358	
Supplementary cost for wood side panels	each couple	578	
START door – extra charge for "M" handle	each.	47	
GRIP door – extra charge for Eco Skin version	each.	22	

W 2654

modules 1312 - 1312

- For visible side panels with Cartapaglia and Silk melamine front, include the supplementary cost for matt lacquered side panels.
- For custom reduction surcharges check on page 36

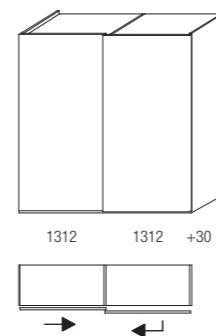

	QUICK	A FILO	BLADE	START	GRIP
Structure with doors	US/D	FS/D	BS/D	SS/D	GS/D
melamine front	2.958	3.066	3.066	2.909	2.909
matt lacquer colours		3.370	3.370	3.213	3.213
vertical grain wood		4.651	4.651	4.488	4.488
glossy lacquer colours		5.494	5.494	5.330	5.330
coloured/etched col. glass		5.280			

Internal fittings



A Complete fittings € **159**

	Code	Q.ty	€
Wood shelves W 1282	RI/13	1	77
"Smart" clothes rails W 1282	PP/13	2	82

D Complete fittings € **672**

	Code	Q.ty	€
Wood shelves W 1282	RI/13	1	77
"Smart" clothes rails W 1282	PP/13	2	82
"Smart" drawer units 2 drawers W 1282	CNT13/04PB	1	513

B Complete fittings € **801**

	Code	Q.ty	€
Wood shelves W 1282	RI/13	1	77
"Smart" clothes rails W 1282	PP/13	1	41
"Smart" drawer units 3 drawers W 1282	CNT13/06PA	1	683

E Complete fittings € **397**

	Code	Q.ty	€
Wood shelves W 1282	RI/13	1	77
"Smart" clothes rails W 1282	PP/13	1	41
Dividing panels H 1158	SDT/11	1	102
Wood shelves W 626	RI/6	3	153
"Smart" clothes rails W 626	PP/06	1	24

C Complete fittings € **821**

	Code	Q.ty	€
Wood shelves W 1282	RI/13	4	308
"Smart" drawer units 2 drawers W 1282	CNT13/04PB	1	513

Lighting system complete with sensors power supply and connector

N.1 vertical LED bar each compartment	542	excluding remote control
N.2 vertical LED bars each compartment	845	excluding remote control

Additional elements

Code	€	Code	€
Wood shelf W 1282	RI/13	77	
Wood shelf W 626	RI/6	51	
"Smart" clothes rails W 1282	PP/13	41	
"Smart" clothes rails W 626	PP/06	24	
"Smart" drawer unit 2 drawers W 1282	CNT13/04PB	513	
"Smart" drawer unit 3 drawers W 1282	CNT13/06PA	683	
"Smart" drawer unit 4 drawers W 1282	CNT13/08PA	852	
"Smart" drawer unit 2 drawers W 626	CNT6/04PB	366	
"Smart" drawer unit 3 drawers W 626	CNT6/06PA	497	
"Smart" drawer unit 4 drawers W 626	CNT6/08PA	627	
Supplementary cost for matt lacq. side panels	each couple	226	
Supplementary cost for glossy lacq. side panels	each couple	358	
Supplementary cost for wood side panels	each couple	578	
START door – extra charge for "M" handle	each.	47	
GRIP door – extra charge for Eco Skin version	each.	22	

W 2982

modules 984 - 984 - 984

- For visible side panels with Cartapaglia and Silk melamine front, include the supplementary cost for matt lacquered side panels.
- For custom reduction surcharges check on page 36

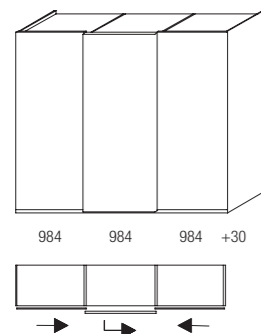

	QUICK	A FILO	BLADE	START	GRIP
Structure with doors	US/F	FS/F	BS/F	SS/F	GS/F
melamine front	3.509	3.672	3.672	3.438	3.438
matt lacquer colours		4.105	4.105	3.863	3.863
vertical grain wood		5.553	5.553	5.308	5.308
glossy lacquer colours		6.331	6.331	6.071	6.071
coloured/etched col. glass		6.657			

Internal fittings



A Complete fittings € **116**

Code	Q.ty	€
RI/9	1	60
PP/09	2	56

B Complete fittings € **638**

Code	Q.ty	€
RI/9	1	60
PP/09	1	28
CNT9/06PA	1	550

C Complete fittings € **645**

Code	Q.ty	€
RI/9	4	240
CNT9/04PB	1	405

D Complete fittings € **521**

Code	Q.ty	€
RI/9	1	60
PP/09	2	56
CNT9/04PB	1	405

E Complete fittings € **335**

Code	Q.ty	€
RI/9	1	60
PP/09	1	28
SDT/11	1	102
RI/4	3	123
PP/04	1	22

Lighting system complete with sensors power supply and connector

N.1 vertical LED bar each compartment	772	excluding remote control
N.2 vertical LED bars each compartment	1.292	excluding remote control

Additional elements	Code	€	Additional elements	Code	€
Wood shelf W 954	RI/9	60	"Smart" drawer unit 3 drawers W 462	CNT4/06PA	448
Wood shelf W 462	RI/4	41	"Smart" drawer unit 4 drawers W 462	CNT4/08PA	564
"Smart" clothes rails W 954	PP/09	28	Supplementary cost for matt lacq. side panels	each couple	226
"Smart" clothes rails W 462	PP/04	22	Supplementary cost for glossy lacq. side panels	each couple	358
"Smart" drawer unit 2 drawers W 954	CNT9/04PB	405	Supplementary cost for wood side panels	each couple	578
"Smart" drawer unit 3 drawers W 954	CNT9/06PA	550	START door – extra charge for "M" handle	each.	47
"Smart" drawer unit 4 drawers W 954	CNT9/08PA	694	GRIP door – extra charge for Eco Skin version	each.	22
"Smart" drawer unit 2 drawers W 462	CNT4/04PB	331			

W 3310

modules 820 - 820 - 820 - 820

- For visible side panels with Cartapaglia and Silk melamine front, include the supplementary cost for matt lacquered side panels.
- For custom reduction surcharges check on page 36

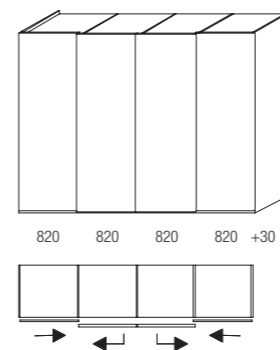

	QUICK	A FILO	BLADE	START	GRIP
Structure with doors	US/G	FS/G	BS/G	SS/G	GS/G
melamine front	4.370	4.584	4.584	4.278	4.278
matt lacquer colours		5.150	5.150	4.836	4.836
vertical grain wood		6.760	6.760	6.438	6.438
glossy lacquer colours		7.848	7.848	7.504	7.504
coloured/etched col. glass		8.316			

Internal fittings

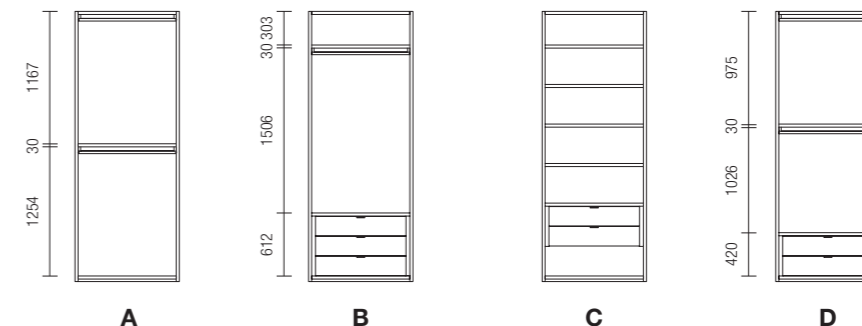

A Complete fittings € **109**

Code	Q.ty	€
RI/8	1	57
PP/08	2	52

B Complete fittings € **607**

Code	Q.ty	€
RI/8	1	57
PP/08	1	26
CNT8/06PA	1	524

C Complete fittings € **614**

Code	Q.ty	€
RI/8	4	228
CNT8/04PB	1	386

D Complete fittings € **495**

Code	Q.ty	€
RI/8	1	57
PP/08	2	52
CNT8/04PB	1	386

Lighting system complete with sensors power supply and connector

N.1 vertical LED bar each compartment	985	excluding remote control
N.2 vertical LED bars each compartment	1.665	excluding remote control

Additional elements	Code	€	Additional elements	Code	€
Wood shelf W 790	RI/8	57	Supplementary cost for matt lacq. side panels	each couple	226
"Smart" clothes rails W 790	PP/08	26	Supplementary cost for glossy lacq. side panels	each couple	358
"Smart" drawer unit 2 drawers W 790	CNT8/04PB	386	Supplementary cost for wood side panels	each couple	578
"Smart" drawer unit 3 drawers W 790	CNT8/06PA	524	START door – extra charge for "M" handle	each.	47
"Smart" drawer unit 4 drawers W 790	CNT8/08PA	661	GRIP door – extra charge for Eco Skin version	each.	22

W 3966

modules 1312 - 1312 - 1312

- For visible side panels with Cartapaglia and Silk melamine front, include the supplementary cost for matt lacquered side panels.
- For custom reduction surcharges check on page 36

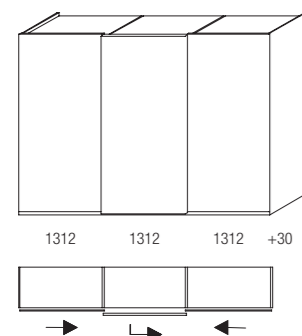

	QUICK	A FILO	BLADE	START	GRIP
Structure with doors	US/K	FS/K	BS/K	SS/K	GS/K
melamine front	4.304	4.466	4.466	4.230	4.230
matt lacquer colours		4.922	4.922	4.686	4.686
vertical grain wood		6.843	6.843	6.598	6.598
glossy lacquer colours		8.108	8.108	7.862	7.862
coloured/etched col. glass		7.793			

Internal fittings

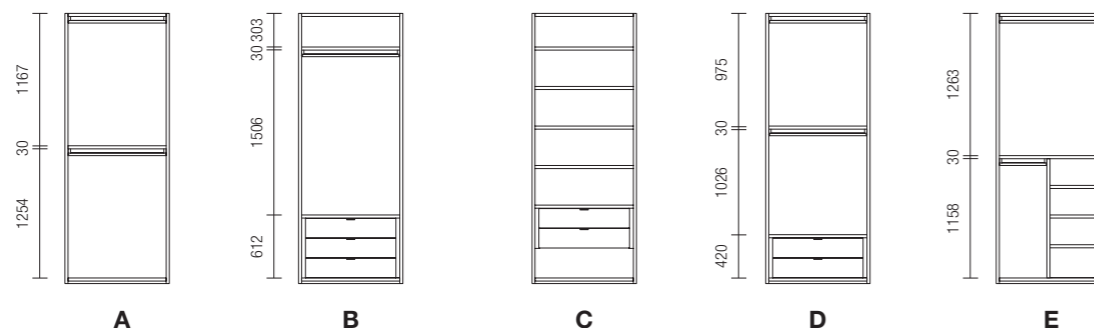

A Complete fittings € 159	Code	Q.ty	€
Wood shelves W 1282	RI/13	1	77
"Smart" clothes rails W 1282	PP/13	2	82

B Complete fittings € 801	Code	Q.ty	€
Wood shelves W 1282	RI/13	1	77
"Smart" clothes rails W 1282	PP/13	1	41
"Smart" drawer units 3 drawers W 1282	CNT13/06PA	1	683

C Complete fittings € 821	Code	Q.ty	€
Wood shelves W 1282	RI/13	4	308
"Smart" drawer units 2 drawers W 1282	CNT13/04PB	1	513

D Complete fittings € 672	Code	Q.ty	€
Wood shelves W 1282	RI/13	1	77
"Smart" clothes rails W 1282	PP/13	2	82
"Smart" drawer units 2 drawers W 1282	CNT13/04PB	1	513

E Complete fittings € 397	Code	Q.ty	€
Wood shelves W 1282	RI/13	1	77
"Smart" clothes rails W 1282	PP/13	1	41
Dividing panels H 1158	SDT/11	1	102
Wood shelves W 626	RI/6	3	153
"Smart" clothes rails W 626	PP/06	1	24

Lighting system complete with sensors power supply and connector

N.1 vertical LED bar each compartment	772	excluding remote control
N.2 vertical LED bars each compartment	1.292	excluding remote control

Additional elements	Code	€	Code	€
Wood shelf W 1282	RI/13	77	"Smart" drawer unit 3 drawers W 626	CNT6/06PA 497
Wood shelf W 626	RI/6	51	"Smart" drawer unit 4 drawers W 626	CNT6/08PA 627
"Smart" clothes rails W 1282	PP/13	41	Supplementary cost for matt lacq. side panels	each couple 226
"Smart" clothes rails W 626	PP/06	24	Supplementary cost for glossy lacq. side panels	each couple 358
"Smart" drawer unit 2 drawers W 1282	CNT13/04PB	513	Supplementary cost for wood side panels	each couple 578
"Smart" drawer unit 3 drawers W 1282	CNT13/06PA	683	START door – extra charge for "M" handle	each. 47
"Smart" drawer unit 4 drawers W 1282	CNT13/08PA	852	GRIP door – extra charge for Eco Skin version	each. 22
"Smart" drawer unit 2 drawers W 626	CNT6/04PB	366		

W 3966

modules 984 - 984 - 984 - 984

- For visible side panels with Cartapaglia and Silk melamine front, include the supplementary cost for matt lacquered side panels.
- For custom reduction surcharges check on page 36

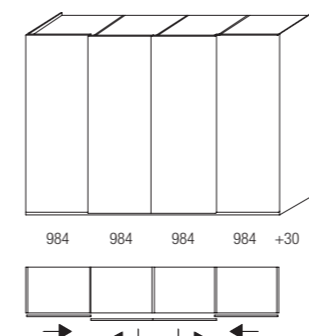

	QUICK	A FILO	BLADE	START	GRIP
Structure with doors	US/L	FS/L	BS/L	SS/L	GS/L
melamine front	4.624	4.840	4.840	4.530	4.530
matt lacquer colours		5.420	5.420	5.098	5.098
vertical grain wood		7.350	7.350	7.024	7.024
glossy lacquer colours		8.390	8.390	8.046	8.046
coloured/etched col. glass		8.816			

Internal fittings



A Complete fittings € 116	Code	Q.ty	€
Wood shelves W 954	RI/9	1	60
"Smart" clothes rails W 954	PP/09	2	56

B Complete fittings € 638	Code	Q.ty	€
Wood shelves W 954	RI/9	1	60
"Smart" clothes rails W 954	PP/09	1	28
"Smart" drawer units 3 drawers W 954	CNT9/06PA	1	550

C Complete fittings € 645	Code	Q.ty	€
Wood shelves W 954	RI/9	4	240
"Smart" drawer units 2 drawers W 954	CNT9/04PB	1	405

D Complete fittings € 521	Code	Q.ty	€
Wood shelves W 954	RI/9	1	60
"Smart" clothes rails W 954	PP/09	2	56
"Smart" drawer units 2 drawers W 954	CNT9/04PB	1	405

E Complete fittings € 335	Code	Q.ty	€
Wood shelves W 954	RI/9	1	60
"Smart" clothes rails W 954	PP/09	1	28
Dividing panels H 1158	SDT/11	1	102
Wood shelves W 462	RI/4	3	123
"Smart" clothes rails W 462	PP/04	1	22

Lighting system complete with sensors power supply and connector

N.1 vertical LED bar each compartment	985	excluding remote control
N.2 vertical LED bars each compartment	1.665	excluding remote control

Additional elements	Code	€	Code	€
Wood shelf W 954	RI/9	60	"Smart" drawer unit 3 drawers W 462	CNT4/06PA 448
Wood shelf W 462	RI/4	41	"Smart" drawer unit 4 drawers W 462	CNT4/08PA 564
"Smart" clothes rails W 954	PP/09	28	Supplementary cost for matt lacq. side panels	each couple 226
"Smart" clothes rails W 462	PP/04	22	Supplementary cost for glossy lacq. side panels	each couple 358
"Smart" drawer unit 2 drawers W 954	CNT9/04PB	405	Supplementary cost for wood side panels	each couple 578
"Smart" drawer unit 3 drawers W 954	CNT9/06PA	550	START door – extra charge for "M" handle	each. 47
"Smart" drawer unit 4 drawers W 954	CNT9/08PA	694	GRIP door – extra charge for Eco Skin version	each. 22
"Smart" drawer unit 2 drawers W 462	CNT4/04PB	331		

Structure reductions

Type of reduction	height	€	width	€	depth	€
Linear modules D 595 mm melamine back	per millimetre	49	per millimetre	147	min -20 mm max -256 wardrobe / flush sliding ward. max -160 mm	98
Linear modules D 435 mm	per millimetre	49	per millimetre	147	min -20 mm max -96 mm	98
Wooden central partition or side panel	per millimetre	49	per millimetre		depend on linear modules	49

The retailer should remember to verify the stability of wardrobes having a depth inferior to 595 mm and arrange to have anti-tilt devices mounted if necessary.

Door reductions

Type of reduction	height	€	width	€
Wooden hinged doors FIND-ME - QUICK - START - TWIN - A FILO - HOLLOW - GRIP	per millimetre	63	per millimetre	63
A FILO glass hinged doors - SMOOTH hinged doors	per millimetre	126	per millimetre	126
Wooden sliding doors QUICK - START - A FILO - BLADE - GRIP	per millimetre	63	only doors W 979 and 1307 mm - reducible down to W 815 mm	63
A FILO glass sliding doors	per millimetre	126	no reductions	

Reductions of internal fittings

Type of reduction	width	€	depth	€
Wood shelves	per millimetre	49*	depend on linear modules	49
Clothes rails	per millimetre	7		
“Smart” drawer unit 2 drawers	per millimetre	105	no reductions	
“Smart” drawer unit 3 drawers	per millimetre	140	no reductions	
“Smart” drawer unit 4 drawers	per millimetre	175	no reductions	

* If the corner shelves are reduced on two sides, consider double the cost.

**GLISS MASTER
SMART FITTINGS**